

### ◆ Features

- Collector current  $I_C=0.4A$ .
- Power amplifier applications.
- Complementary to BC807-40

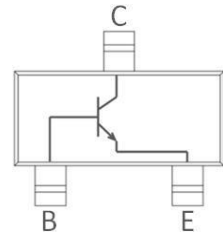

### ◆ Absolute Maximum Ratings( $T_a=25^\circ C$ )

Symbol	Parameter	Value	Unit
$V_{CBO}$	Collector-Base Voltage	40	V
$V_{CEO}$	Collector-Emitter Voltage	25	V
$V_{EBO}$	Emitter-Base Voltage	5	V
$I_C$	Collector Current	0.4	A
$P_C$	Collector Power Dissipation	300	mW
$R_{\theta JA}$	Thermal Resistance From Junction To Ambient	400	$^\circ C/W$
$T_J, T_{stg}$	Operation Junction And Storage Temperature Range	-55~+150	$^\circ C$

### ◆ Electrical Characteristics ( $T_a=25^\circ C$ unless otherwise specified)

Symbol	Parameter	Test conditions	Min	Typ	Max	Unit
$V_{(BR)CBO}$	Collector-base breakdown voltage	$I_C=100\mu A, I_E=0$	40			V
$V_{(BR)CEO}$	Collector-emitter breakdown voltage	$I_C=0.1mA, I_B=0$	25			V
$V_{(BR)EBO}$	Emitter-base breakdown voltage	$I_E=100\mu A, I_C=0$	5			V
$I_{CEO}$	Collector cut-off current	$V_{CE}=20V, I_E=0$			100	nA
$I_{CBO}$	Collector cut-off current	$V_{CB}=40V, I_E=0$			100	nA
$I_{EBO}$	Emitter cut-off current	$V_{EB}=5V, I_C=0$			100	nA
$h_{FE(1)}$	DC current gain(1)	$V_{CE}=1V, I_C=50mA$	200		350	
$h_{FE(2)}$	DC current gain(2)	$V_{CE}=1V, I_C=500mA$	50			
$V_{CE(sat)}$	Collector-emitter saturation voltage	$I_C=500mA, I_B=50mA$			0.6	V
$V_{BE(sat)}$	Base-emitter saturation voltage				1.2	V
$f_T$	Transition frequency	$V_{CE}=6V, I_C=20mA, f=30MHz$	150			MHz

### ◆ $h_{FE(1)}$ Classifications & Marking

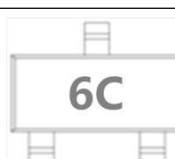
$h_{FE(1)}$	200~350
Marking	

Recommend Reflow Soldering temperature profile

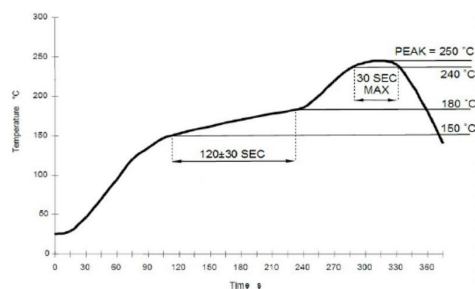

One time Reflow maximum (In reference to ICE60068-2-5)

### ◆ Typical Characteristics

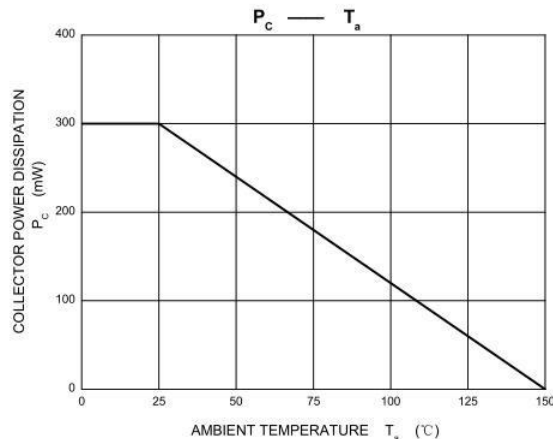
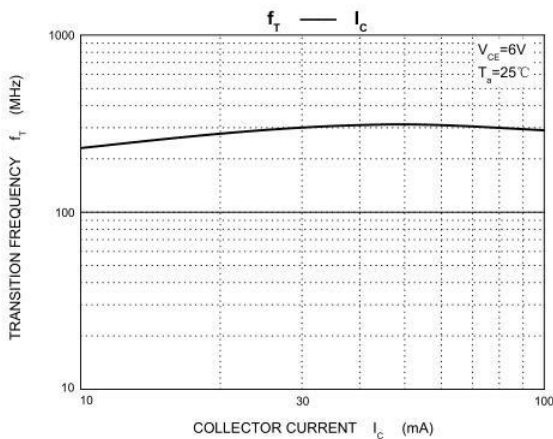
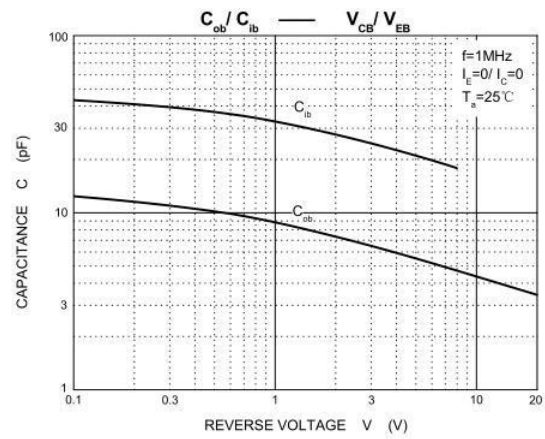
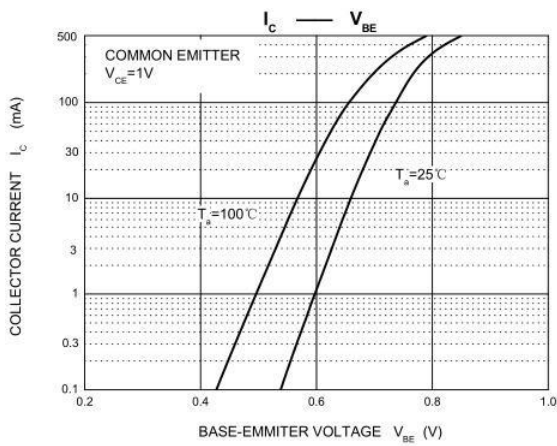
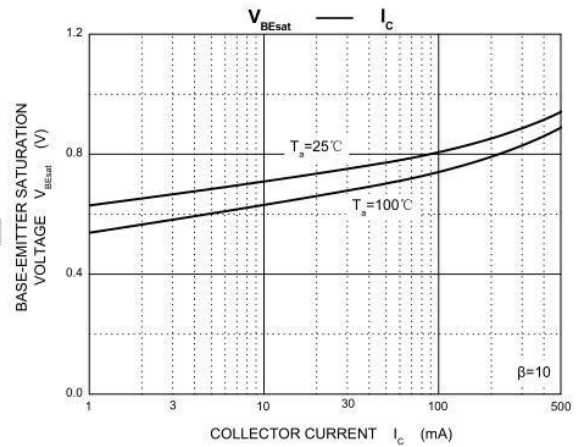
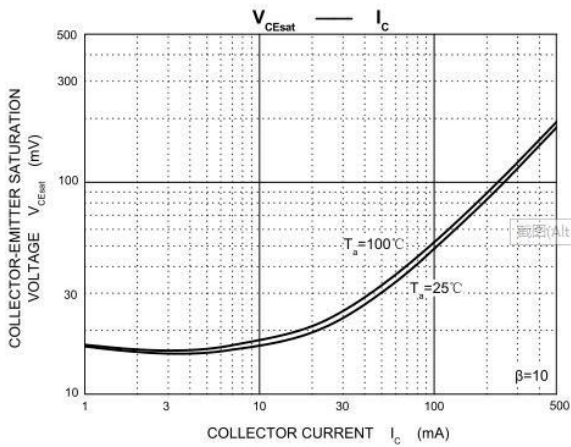
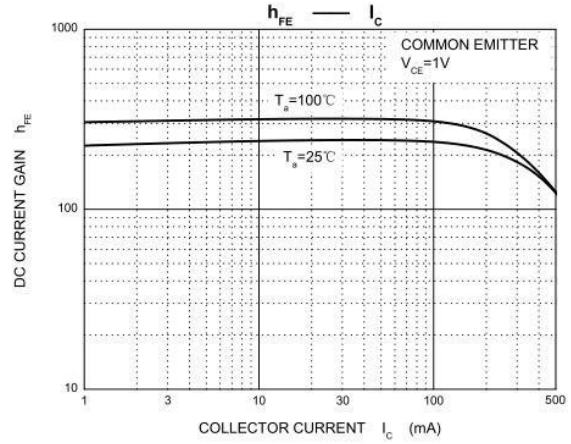
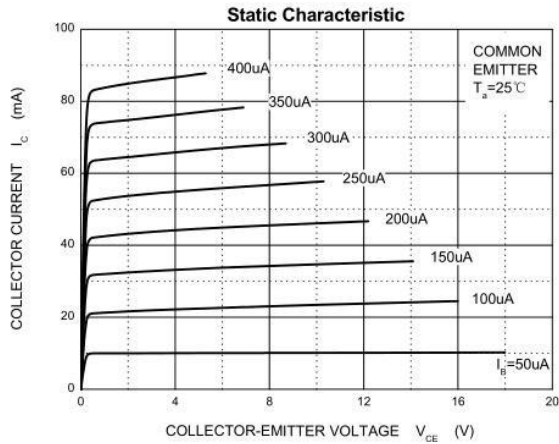

◆ SOT-23 Package Outline Dimensions

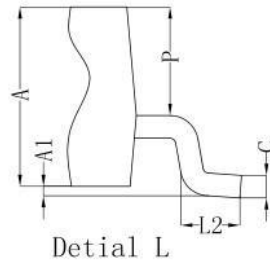
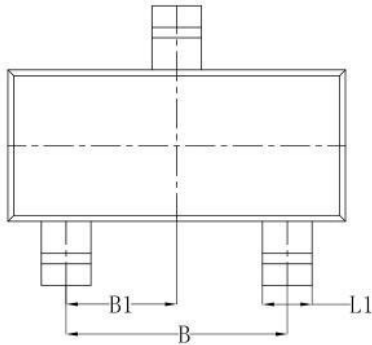
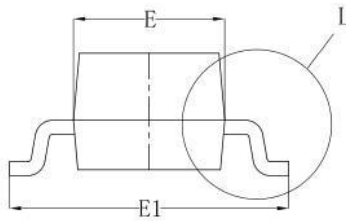
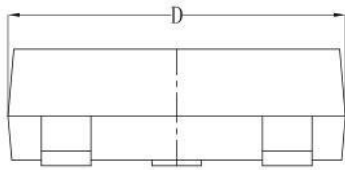

Symbol	Dim in mm		
	Min	Nom	Max
A	0.900	1.000	1.100
A1	0.000	0.050	0.100
B	1.800	1.900	2.000
B1	0.950 TYP		
C	0.100	0.110	0.120
D	2.800	2.900	3.000
E	1.250	1.300	1.350
E1	2.250	2.400	2.550
L1	0.350	0.400	0.500
L2	0.200	0.350	0.450
P	0.550	0.575	0.600

◆ Packaging SPEC.

Units				
Units/Reel	Reels/Inner Box	Units/Inner Box	Inner Boxes/Outer Box	Units/Outer Box
3,000	15	45,000	4	180,000
Reel	Dimension (unit: mm <sup>3</sup> )			
	Inner Box		Outer Box	
7" × 8	190×190×190		400×400×210	

### SOT-23 Embossed Carrier Tape

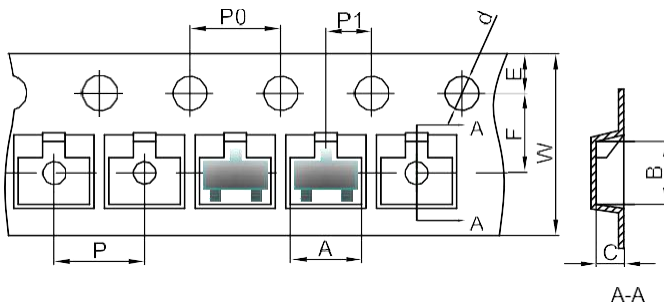

**Packaging Description:**

SOT-23 parts are shipped in tape. The carrier tape is made from a dissipative (carbon filled) polycarbonate resin. The cover tape is a multilayer film (Heat Activated Adhesive in nature) primarily composed of polyester film, adhesive layer, sealant, and anti-static sprayed agent. These reeled parts in standard option are shipped with 3,000 units per 7" or 17.8cm diameter reel. The reels are clear in color and is made of polystyrene plastic (anti-static coated).

Dimensions are in millimeter										
Pkg type	A	B	C	d	E	F	P0	P	P1	W
SOT-23	3.15	2.77	1.22	Ø1.50	1.75	3.50	4.00	4.00	2.00	8.00

### SOT-23 Tape Leader and Trailer

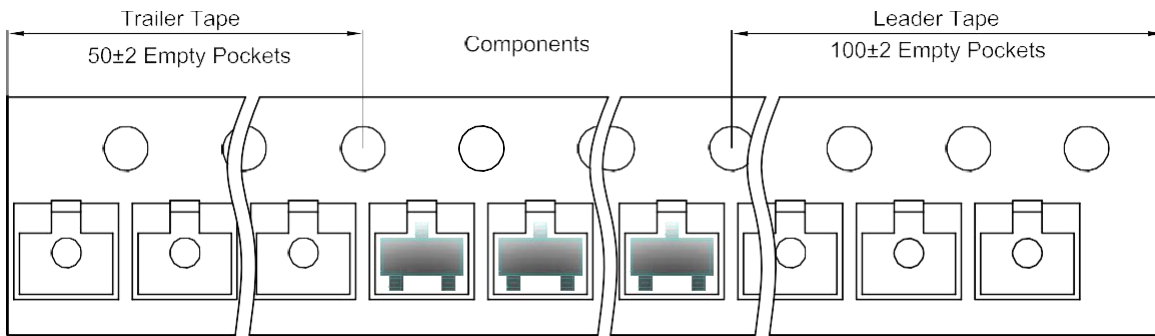

### SOT-23 Reel

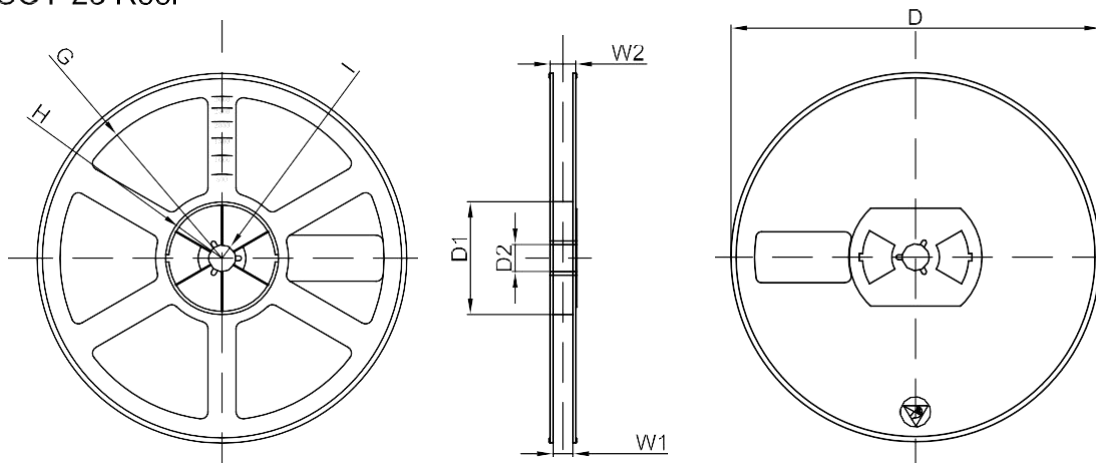

Dimensions are in millimeter								
Reel Option	D	D1	D2	G	H	I	W1	W2
7"Dia	Ø178.00	54.40	13.00	R78.00	R25.60	R6.50	9.50	12.30

REEL	Reel Size	Box	Box Size(mm)	Carton	Carton Size(mm)	G.W.(kg)
3000 pcs	7 inch	45,000 pcs	203×203×195	180,000 pcs	438×438×220	